



*Quality Products. Service Excellence.*

## Type 4, 4X Stainless Steel Pushbutton Enclosures *1437SS Series*

Extra Deep



### Application

- Designed to accept standard heavy duty oil tight pushbuttons, switches and pilot lights.
- Provides protection from dirt, dust, oil and water.

### Standards

- UL 508A Type 4 and 4X
- CSA Enclosure 4 and 4X
- **Complies with**
  - NEMA Type 4 and 4X
  - IEC 60529, IP66
  - JIC STD EGP-1-1967
- Appropriate components are required to maintain these standards.

### Construction

- Formed from 14 gauge steel except A which is 16 gauge.
- Smooth continuously welded seams.
- Welded brackets provide for enclosure mounting.
- Captive cover screws fasten into threaded, sealed wells.
- Larger enclosures provide internally hinged removable covers, designed to hold the cover open during wiring (see table).
- Oil resistant gasket and adhesive.
- A bonding stud is provided on the door and a grounding stud is provided on the enclosure.

### Finish

- Natural stainless steel with a smooth brushed finish.

### Accessories

- Hole Plugs
- Ground Wire Kits
- Pedestal and Base

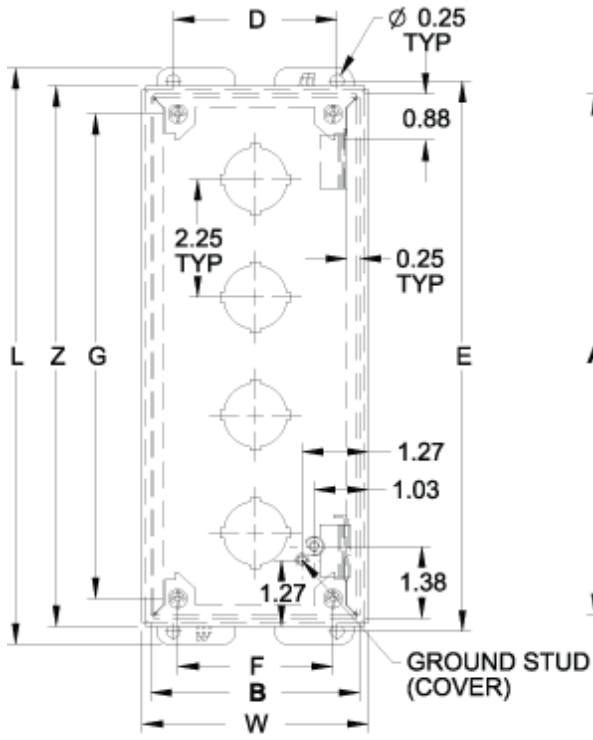

**Front View**  
Body Type B through S  
(Hinged)

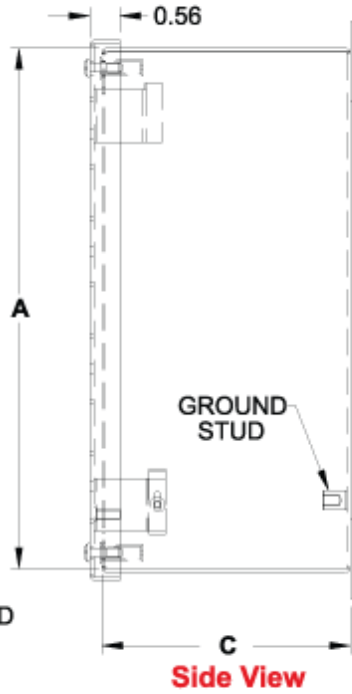

**Side View**

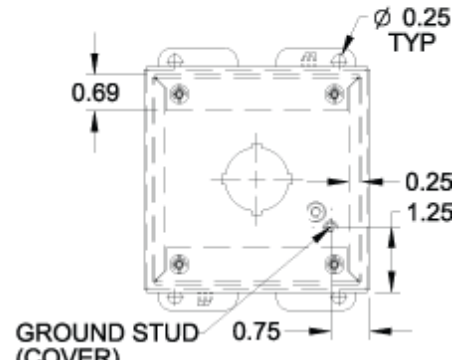

**Front View**  
Body Type A  
(Not Hinged)

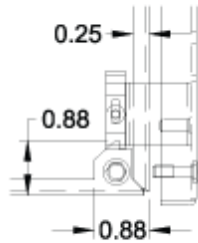

**Hinge Detail**

Retractable pin allows door to be mounted on left or right side

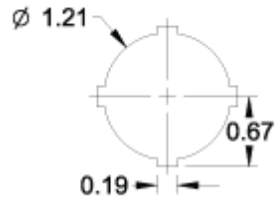

**22.5mm Detail**  
(1437M Series)

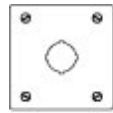

**1**



**2**

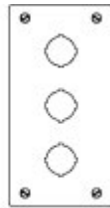

**3**

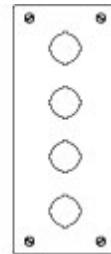

**4**

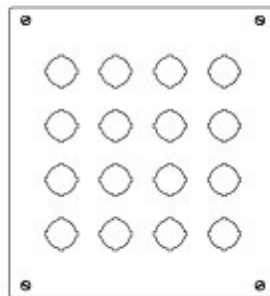

**16**

Part No.	No. Of	Overall Dimensions	Z
----------	--------	--------------------	---

304 SS 22.5mm	304 SS 30.5mm	316 SS 22.5mm	316 SS 30.5mm	Holes	A	B	C	D	E	F	G	Overall Dimensions		Z
304 SS 22.5mm	304 SS 30.5mm	316 SS 22.5mm	316 SS 30.5mm	Holes	A	B	C	D	E	F	G	L	W	
1437MSSA <sup>1</sup>	1437SSA <sup>1</sup>	1437MS16A <sup>1</sup>	1437S16A <sup>1</sup>	1	4.00	4.00	4.75	3.13	4.50	2.96	3.25	5.00	4.31	4.31
1437MSSB	1437SSB	1437MS16B	1437S16B	2	6.00	4.00	4.75	3.13	6.50	2.96	5.25	7.00	4.31	6.31
1437MSSC	1437SSC	1437MS16C	1437S16C	3	8.00	4.00	4.75	3.13	8.50	2.96	7.25	9.00	4.31	8.31
1437MSSD	1437SSD	1437MS16D	1437S16D	4	10.00	4.00	4.75	3.13	10.50	2.96	9.25	11.00	4.31	10.31
-	1437SSS	-	1437S16S	16	11.75	10.75	4.75	9.88	12.25	9.71	11.00	12.75	11.06	12.06

<sup>1</sup> Not hinged

Data subject to change without notice

© 2018. Hammond Manufacturing Ltd. All rights reserved.